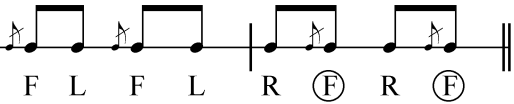
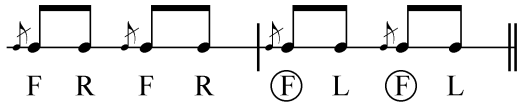

1. ФОРШЛАГ FLAM

A. Одна нота с форшлагом в фигуре One note with flam in the figure

Используйте схему 4-2-1-1 (8-4-2-1-1).
Use the scheme 4-2-1-1 (8-4-2-1-1).

1a. 
F L F L R (F) R (F)

1b. 
F R F R (F) L (F) L

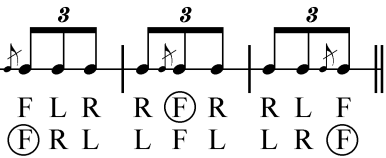
2a. 
F L R R (F) R R L F
(F) R L L F L L R (F)

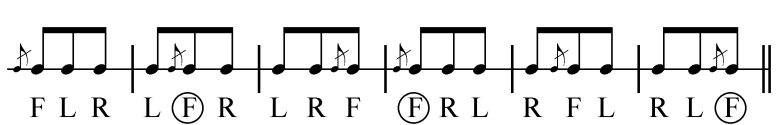
2b. 
F L R L (F) R L R F (F) R L R F L R L (F)

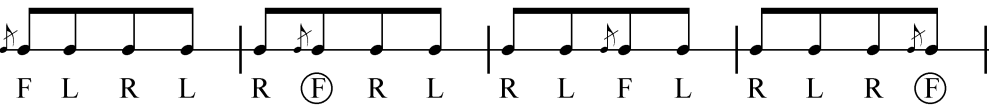
3. 
F L R L R (F) R L R L F L R L R (F)

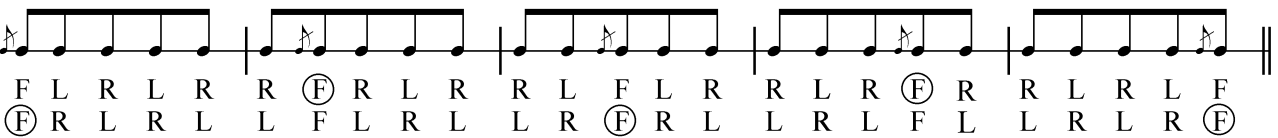
4. 
F L R L R R (F) R L R R L F L R R L R (F) R R L R L F
(F) R L R L L F L R L L R (F) R L L R L F L L R L R (F)

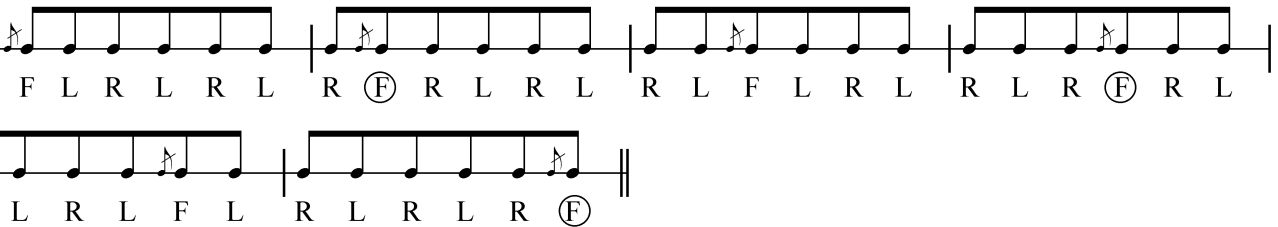
5. 
F L R L R L R (F) R L R L R L F L R L R L R (F) R L
R L R L F L R L R L R L R (F)

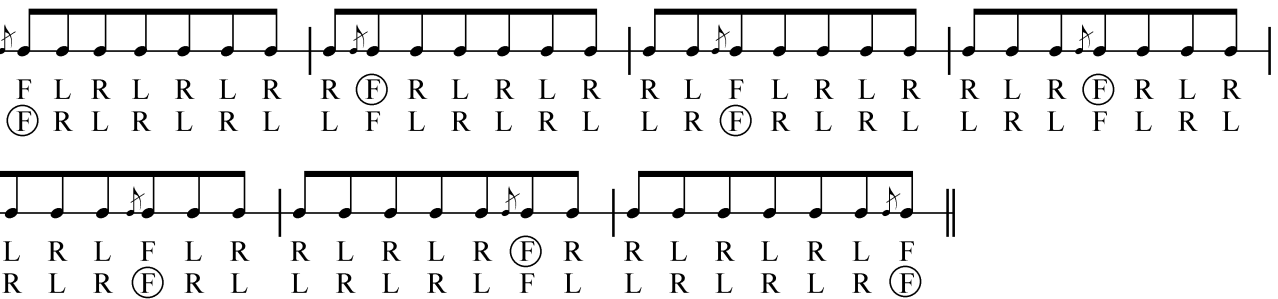
6. 
F L R L R L R R (F) R L R L R R L F L R L R R L R (F) R L R
(F) R L R L R L L F L R L R L L R (F) R L R L L R L F L R L
R L R L F L R R L R L R (F) R R L R L R L F
L R L R (F) R L L R L R L F L L R L R L R (F)

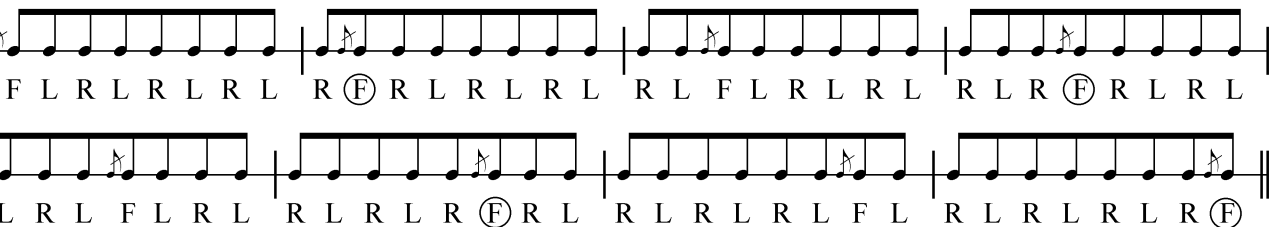
7. 
F L R L R L R L R (F) R L R L R L R L F L R L R L R L R (F) R L R L
R L R L F L R L R L R L R (F) R L R L R L R L F L R L R L R L R (F)